



BÂTIMENT NORD

2^{ÈME} ÉTAGE

-  Surfaces de bureaux
1'095.30 m²
-  Surfaces de circulations
25.80 m²
-  Locaux techniques

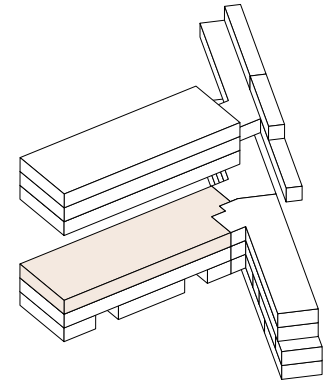
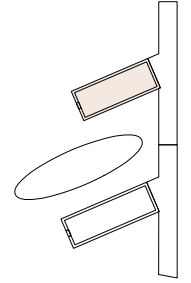

0 5 10 25 m

Les surfaces utiles effectives peuvent varier par rapport aux indications des plans. Sous réserve de modifications.